

# POLYWOOD

## Assembly Instructions



### L1D84, L1R84, L1B84

### For Use With Rectangle Plank Tables-PL84



### 20-year warranty

View our full warranty:  
[polywoodoutdoor.com/warranty](https://polywoodoutdoor.com/warranty)



### Having trouble?

If you have questions or concerns regarding assembly instructions or missing parts, please contact us at [hello@polywoodoutdoor.com](mailto:hello@polywoodoutdoor.com) or (833) 665-6300



### Cleaning tips

#### For a Quick Clean:

Simply wipe down with soap and water.

#### For a Deep Clean:

Wipe on  $\frac{1}{3}$  bleach and  $\frac{2}{3}$  water solution with a clean cloth and let it sit on the lumber for a few minutes (this will not affect the color). Then, loosen any dirt and debris that may catch in surface grooves with a soft bristle brush; hose down to rinse.

#### For a High-Power Clean:

Use a pressure power washer (not exceeding 1,500 psi) to spray off dirt and debris. Apply a  $\frac{1}{3}$  bleach and  $\frac{2}{3}$  water solution and scrub with a soft-bristle brush. Hose down to rinse.

# Thank You

Thank you for choosing POLYWOOD!  
We hope our furniture helps create a gathering place for you and your loved ones to enjoy for many years to come!



### Reach Out

Let us know how we're doing:  
[hello@polywoodoutdoor.com](mailto:hello@polywoodoutdoor.com)  
(833) 665-6300



### Stay Connected

Be the first to hear about new products, giveaways, and more by signing up for our email list: [polywoodoutdoor.com/subscribe](https://polywoodoutdoor.com/subscribe)



### Watch & Learn

For assembly tips and videos visit:  
[polywoodoutdoor.com/assembly](https://polywoodoutdoor.com/assembly)

### Share your space

We love to see where our furniture ends up — snap a pic and tag it on Instagram or Facebook for your chance to be featured on our social channels!  
**#polywood #rethinkoutdoor**



[facebook.com/polywoodoutdoor](https://facebook.com/polywoodoutdoor)



[@POLYWOOD](https://www.instagram.com/POLYWOOD)



[pinterest.com/polywood](https://pinterest.com/polywood)



[youtube.com/polywood](https://youtube.com/polywood)

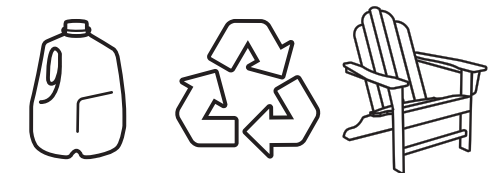

### Did you know?

POLYWOOD was the original outdoor furniture made from recycled materials.

Learn more about our story:  
[genuinePOLYWOOD.com](https://genuinePOLYWOOD.com)

## TOOLS



3/8" wrench  
(not included)



4mm T-handle  
hex key (included)

## PARTS



Separate box



**A** x 8



3" Screw — HHW14X3

**B** x 8



3" Screw — H.27X3

# 1

Align each screw with a pilot hole and partially thread by hand before fully tightening



If legs have relaxed during transit, they may be guided into pilot hole alignment



# 2



Removable  
table plug



Something missing?  
Call (833) 665-6300

# POLYWOOD

# POLYWOOD®

## Assembly Instructions

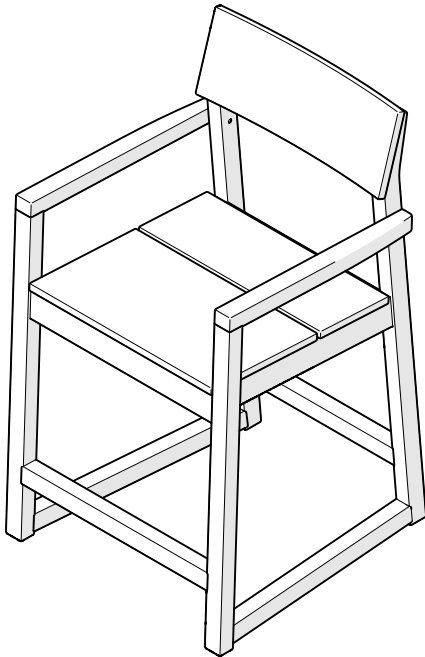

**NO ASSEMBLY REQUIRED**

# EMD201

## EDGE Counter Arm Chair

[polywood.com](http://polywood.com)

# Thank You

Thank you for choosing POLYWOOD!  
We hope your new furniture helps create a  
gathering place for you and your loved ones  
to enjoy for many years to come!



## Join the POLYWOOD Owner's Community

Sign up at:

[polywood.com/welcome](http://polywood.com/welcome)

As a POLYWOOD Owner, you'll be among  
the first to access exclusive information  
about new product launches, special  
promotions, and giveaways.



## Reach Out

Questions? Please contact us:

Live Chat on [polywood.com](http://polywood.com)

[hello@polywood.com](mailto:hello@polywood.com)

(855) 935-5550



## Watch & Learn

For assembly tips and videos visit:

[polywood.com/assembly](http://polywood.com/assembly)

## Share your space

We love to see where your furniture ends up — snap a pic and tag it on Instagram or Facebook for your chance to be featured on our social channels!

**#polywood #loveyouroutdoors**



[facebook.com/polywoodoutdoor](https://facebook.com/polywoodoutdoor)



[@POLYWOOD](https://www.instagram.com/POLYWOOD)



[pinterest.com/polywood](https://pinterest.com/polywood)



[youtube.com/polywood](https://youtube.com/polywood)



## Did you know?

On average, POLYWOOD recycles up to 400,000 milk jugs a day!

Learn more about our story:

**[genuinePOLYWOOD.com](https://genuinePOLYWOOD.com)**



## 20-year warranty

Great news! Your POLYWOOD warranty is already activated, no need to send anything in. Located on the bottom of each item is a sticker with a serial number. **Please keep this number for your records.**

View our full warranty:

**[polywood.com/warranty](https://polywood.com/warranty)**



## Having trouble?

If you have questions or concerns regarding assembly instructions or missing parts, please visit **[help.polywood.com](https://help.polywood.com)** or live chat with our Customer Experience Team on **[polywood.com](https://polywood.com)**.



## Cleaning tips

### **For a Quick Clean:**

Simply wipe down with soap and water.

### **For a Deep Clean:**

Wipe on  $\frac{1}{3}$  bleach and  $\frac{2}{3}$  water solution with a clean cloth and let it sit on the lumber for a few minutes (this will not affect the color). Then, loosen any dirt and debris that may catch in surface grooves with a soft bristle brush; hose down to rinse.

### **For a High-Power Clean:**

Use a pressure power washer (not exceeding 1,500 psi) to spray off dirt and debris. Apply a  $\frac{1}{3}$  bleach and  $\frac{2}{3}$  water solution and scrub with a soft bristle brush. Hose down to rinse.

# POLYWOOD®

## Assembly Instructions

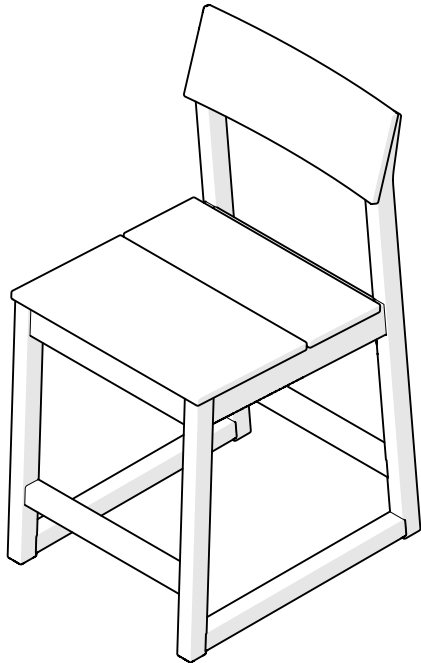

**NO ASSEMBLY REQUIRED**

# EMD101

## EDGE Counter Side Chair

[polywood.com](http://polywood.com)

# Thank You

Thank you for choosing POLYWOOD!  
We hope your new furniture helps create a gathering place for you and your loved ones to enjoy for many years to come!



## Join the POLYWOOD Owner's Community

Sign up at:

[polywood.com/welcome](http://polywood.com/welcome)

As a POLYWOOD Owner, you'll be among the first to access exclusive information about new product launches, special promotions, and giveaways.



## Reach Out

Questions? Please contact us:

Live Chat on [polywood.com](http://polywood.com)

[hello@polywood.com](mailto:hello@polywood.com)

(855) 935-5550



## Watch & Learn

For assembly tips and videos visit:

[polywood.com/assembly](http://polywood.com/assembly)

## Share your space

We love to see where your furniture ends up — snap a pic and tag it on Instagram or Facebook for your chance to be featured on our social channels!

**#polywood #loveyouroutdoors**



[facebook.com/polywoodoutdoor](https://facebook.com/polywoodoutdoor)



[@POLYWOOD](https://www.instagram.com/POLYWOOD)



[pinterest.com/polywood](https://pinterest.com/polywood)



[youtube.com/polywood](https://youtube.com/polywood)

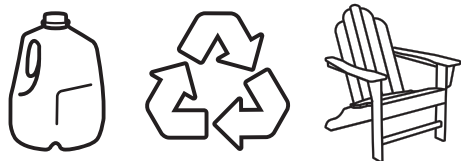

## Did you know?

On average, POLYWOOD recycles up to 400,000 milk jugs a day!

Learn more about our story:

**[genuinePOLYWOOD.com](https://genuinePOLYWOOD.com)**



## 20-year warranty

Great news! Your POLYWOOD warranty is already activated, no need to send anything in. Located on the bottom of each item is a sticker with a serial number. **Please keep this number for your records.**

View our full warranty:

**[polywood.com/warranty](https://polywood.com/warranty)**



## Having trouble?

If you have questions or concerns regarding assembly instructions or missing parts, please visit **[help.polywood.com](https://help.polywood.com)** or live chat with our Customer Experience Team on **[polywood.com](https://polywood.com)**.



## Cleaning tips

### **For a Quick Clean:**

Simply wipe down with soap and water.

### **For a Deep Clean:**

Wipe on  $\frac{1}{3}$  bleach and  $\frac{2}{3}$  water solution with a clean cloth and let it sit on the lumber for a few minutes (this will not affect the color). Then, loosen any dirt and debris that may catch in surface grooves with a soft bristle brush; hose down to rinse.

### **For a High-Power Clean:**

Use a pressure power washer (not exceeding 1,500 psi) to spray off dirt and debris. Apply a  $\frac{1}{3}$  bleach and  $\frac{2}{3}$  water solution and scrub with a soft bristle brush. Hose down to rinse.