

POLYWOOD

Assembly Instructions

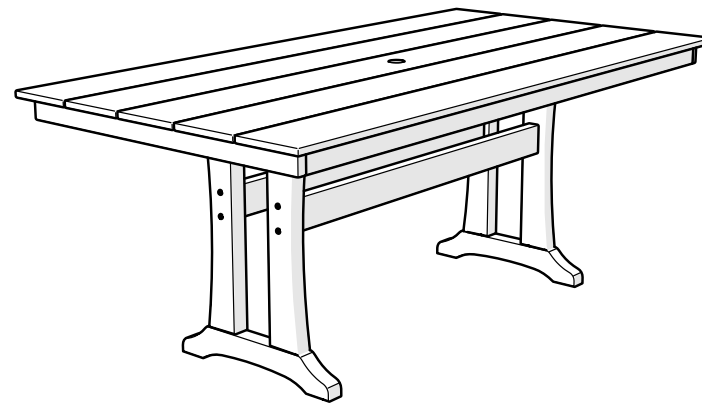

L1D84, L1R84, L1B84

For Use With Rectangle Plank Tables-PL84



20-year warranty

View our full warranty:

polywoodoutdoor.com/warranty



Having trouble?

If you have questions or concerns regarding assembly instructions or missing parts, please contact us at hello@polywoodoutdoor.com or (833) 665-6300



Cleaning tips

For a Quick Clean:

Simply wipe down with soap and water.

For a Deep Clean:

Wipe on $\frac{1}{3}$ bleach and $\frac{2}{3}$ water solution with a clean cloth and let it sit on the lumber for a few minutes (this will not affect the color). Then, loosen any dirt and debris that may catch in surface grooves with a soft bristle brush; hose down to rinse.

For a High-Power Clean:

Use a pressure power washer (not exceeding 1,500 psi) to spray off dirt and debris. Apply a $\frac{1}{3}$ bleach and $\frac{2}{3}$ water solution and scrub with a soft-bristle brush. Hose down to rinse.

Thank You

Thank you for choosing POLYWOOD!
We hope our furniture helps create a gathering place for you and your loved ones to enjoy for many years to come!



Reach Out

Let us know how we're doing:
hello@polywoodoutdoor.com
(833) 665-6300



Stay Connected

Be the first to hear about new products, giveaways, and more by signing up for our email list: polywoodoutdoor.com/subscribe



Watch & Learn

For assembly tips and videos visit:
polywoodoutdoor.com/assembly

Share your space

We love to see where our furniture ends up — snap a pic and tag it on Instagram or Facebook for your chance to be featured on our social channels!
#polywood #rethinkoutdoor



facebook.com/polywoodoutdoor



[@POLYWOOD](https://www.instagram.com/POLYWOOD)



pinterest.com/polywood



youtube.com/polywood

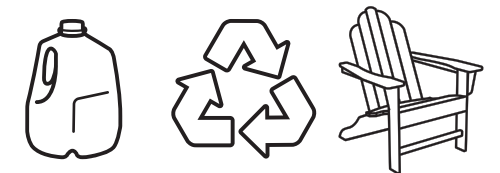

Did you know?

POLYWOOD was the original outdoor furniture made from recycled materials.

Learn more about our story:
genuinePOLYWOOD.com

TOOLS

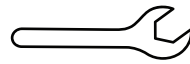

3/8" wrench
(not included)

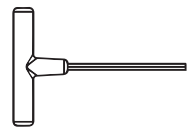

4mm T-handle
hex key (included)

PARTS

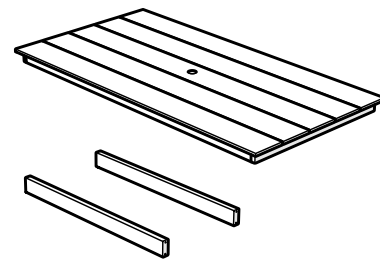

Separate box

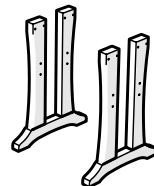

A x 8

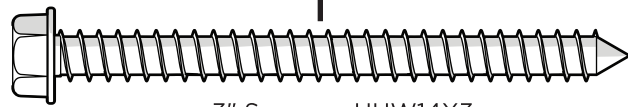

3" Screw — HHW14X3

B x 8

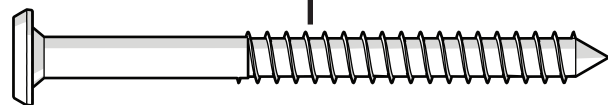

3" Screw — H.27X3

1

Align each screw with a pilot hole and partially thread by hand before fully tightening

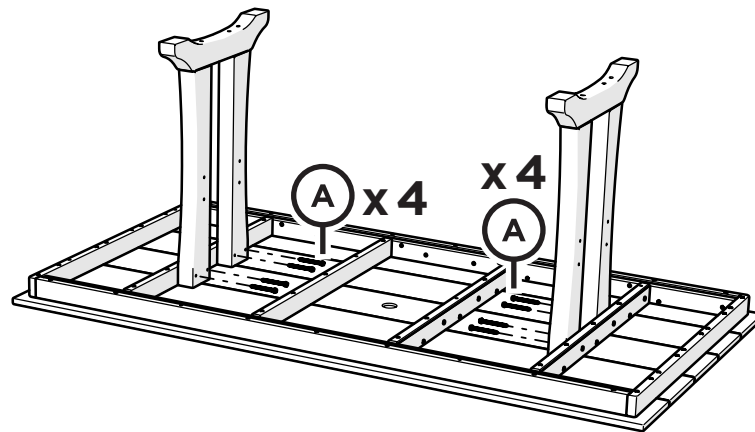

If legs have relaxed during transit, they may be guided into pilot hole alignment

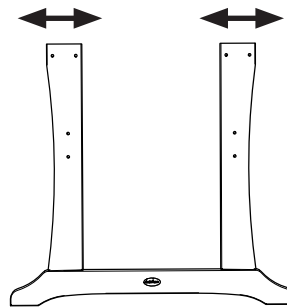

2

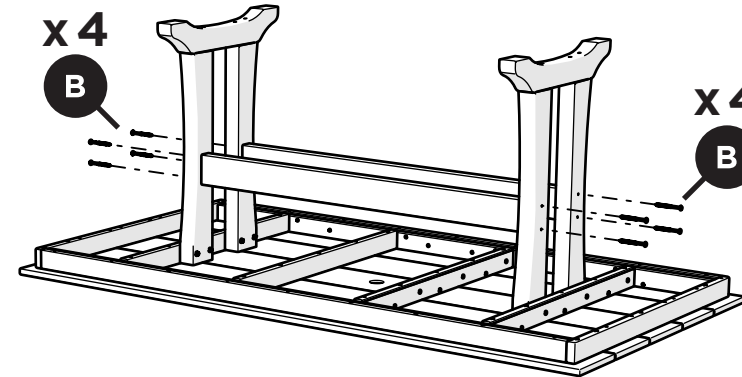

Removable table plug

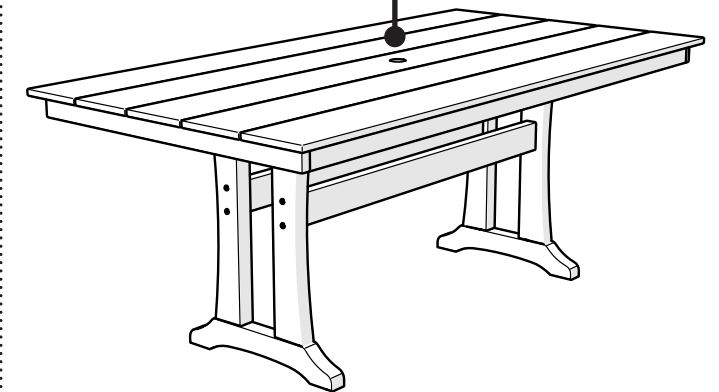

Something missing?
Call (833) 665-6300

POLYWOOD

POLYWOOD

Assembly Instructions

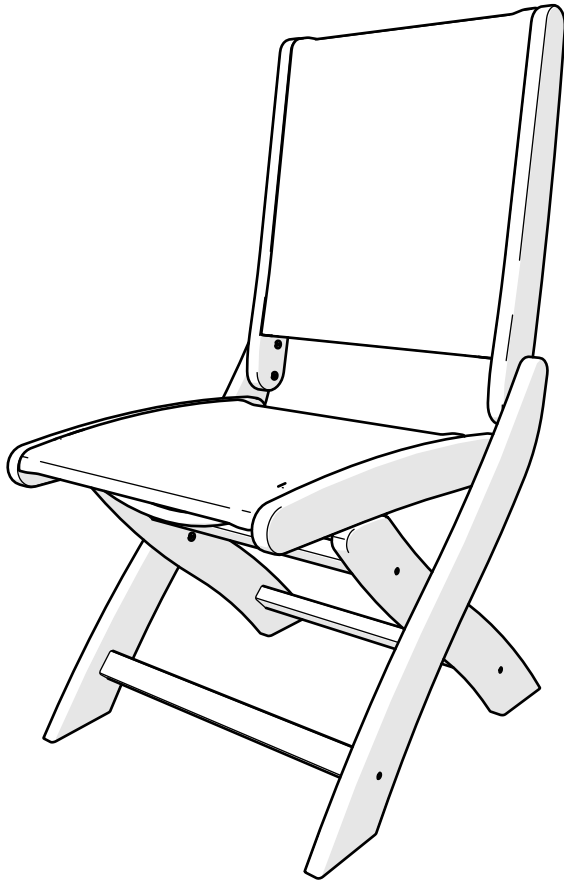

NO ASSEMBLY REQUIRED

9004 Coastal Folding Side Chair

polywoodoutdoor.com

Thank You

Thank you for choosing POLYWOOD!
We hope our furniture helps create a gathering
place for you and your loved ones to enjoy
for many years to come!



Reach Out

Let us know how we're doing:
hello@polywoodoutdoor.com
(833) 665-6300



Stay Connected

Be the first to hear about new products,
giveaways, and more by signing up for our
email list: polywoodoutdoor.com/subscribe



Watch & Learn

For assembly tips and videos visit:
polywoodoutdoor.com/assembly

Share your space

We love to see where our furniture ends up — snap a pic and tag it on Instagram or Facebook for your chance to be featured on our social channels!

#polywood #rethinkoutdoor



facebook.com/polywoodoutdoor



[@POLYWOOD](https://www.instagram.com/POLYWOOD)



pinterest.com/polywood



youtube.com/polywood

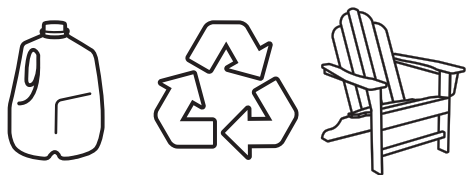

Did you know?

POLYWOOD was the original outdoor furniture made from recycled materials.

Learn more about our story:
genuinePOLYWOOD.com



20-year warranty

View our full warranty:

polywoodoutdoor.com/warranty



Having trouble?

If you have questions or concerns regarding assembly instructions or missing parts, please contact us at **hello@polywoodoutdoor.com** or **(833) 665-6300**



Cleaning tips

For a Quick Clean:

Simply wipe down with soap and water.

For a Deep Clean:

Wipe on $\frac{1}{3}$ bleach and $\frac{2}{3}$ water solution with a clean cloth and let it sit on the lumber for a few minutes (this will not affect the color). Then, loosen any dirt and debris that may catch in surface grooves with a soft bristle brush; hose down to rinse.

For a High-Power Clean:

Use a pressure power washer (not exceeding 1,500 psi) to spray off dirt and debris. Apply a $\frac{1}{3}$ bleach and $\frac{2}{3}$ water solution and scrub with a soft-bristle brush. Hose down to rinse.

POLYWOOD

Assembly Instructions

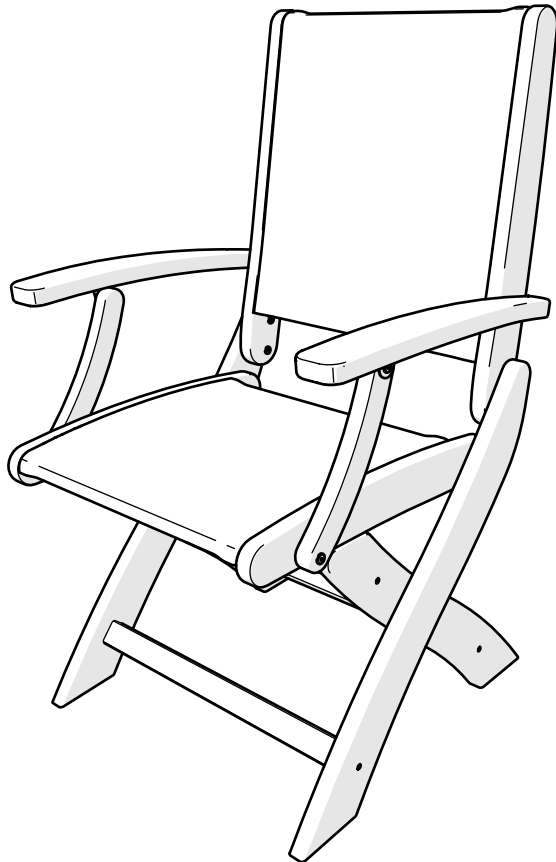

NO ASSEMBLY REQUIRED

9000
Coastal
Folding Chair

polywoodoutdoor.com

Thank You

Thank you for choosing POLYWOOD!
We hope our furniture helps create a gathering
place for you and your loved ones to enjoy
for many years to come!



Reach Out

Let us know how we're doing:
hello@polywoodoutdoor.com
(833) 665-6300



Stay Connected

Be the first to hear about new products,
giveaways, and more by signing up for our
email list: polywoodoutdoor.com/subscribe



Watch & Learn

For assembly tips and videos visit:
polywoodoutdoor.com/assembly

Share your space

We love to see where our furniture ends up — snap a pic and tag it on Instagram or Facebook for your chance to be featured on our social channels!

#polywood #rethinkoutdoor



facebook.com/polywoodoutdoor



[@POLYWOOD](https://instagram.com/POLYWOOD)



pinterest.com/polywood



youtube.com/polywood

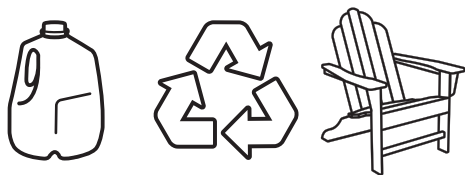

Did you know?

POLYWOOD was the original outdoor furniture made from recycled materials.

Learn more about our story:
genuinePOLYWOOD.com



20-year warranty

View our full warranty:

polywoodoutdoor.com/warranty



Having trouble?

If you have questions or concerns regarding assembly instructions or missing parts, please contact us at **hello@polywoodoutdoor.com** or **(833) 665-6300**



Cleaning tips

For a Quick Clean:

Simply wipe down with soap and water.

For a Deep Clean:

Wipe on $\frac{1}{3}$ bleach and $\frac{2}{3}$ water solution with a clean cloth and let it sit on the lumber for a few minutes (this will not affect the color). Then, loosen any dirt and debris that may catch in surface grooves with a soft bristle brush; hose down to rinse.

For a High-Power Clean:

Use a pressure power washer (not exceeding 1,500 psi) to spray off dirt and debris. Apply a $\frac{1}{3}$ bleach and $\frac{2}{3}$ water solution and scrub with a soft-bristle brush. Hose down to rinse.